

PCB Terminal Blocks, Fixed Horizontal Wire Entry, Double Level, Offset Right ASIWJEK500A-5.08

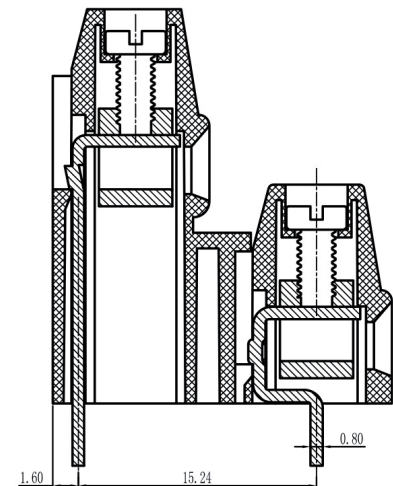
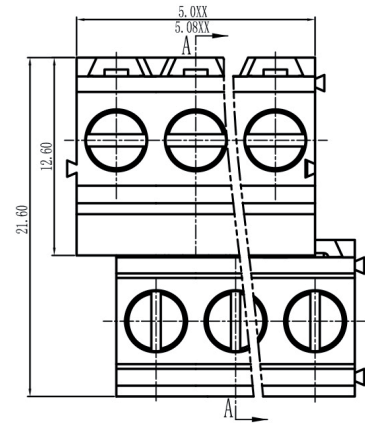
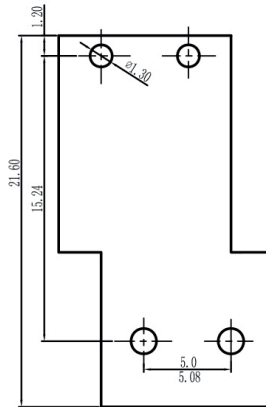
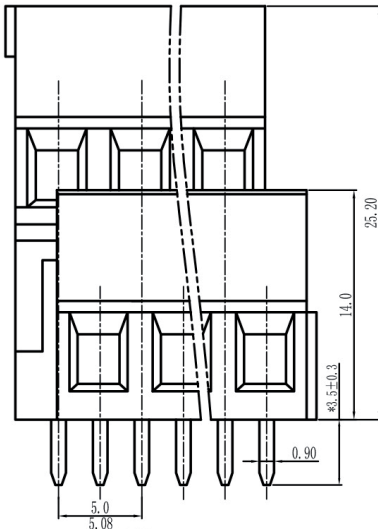

Certification	
Material	
Screw	M2.5, Steel Zinc Plated
Clamp	Brass, Nickel Plated
Pin/Plate	Brass, Tin Plated
Housing	PA66, UL 94V-0, Green
Electrical	
Standard	UL 1059/CSA C22.2 No. 158
Rated Voltage	300 V
Rated Current	15 A
Wire Range	30-14 AWG
Contact Resistance	20mΩ
Insulation Resistance	500MΩ/500 Vdc
Withstand Voltage	2000 Vac/1 Min
Mechanical	
Temperature Range	-40°C...+105°C
Torque	0.4N-m (3.5lb-in)
Strip Length	6-7 mm (0.24-0.28")
Size	
Pitch	5.0 mm (.197")
Poles	2P-3P. Additional sizes available on request.

Item	No. of Poles	Length (mm)
ASIWJEK500A-5.0-2P	2	12.5
ASIWJEK500A-5.0-3P	3	17.5